

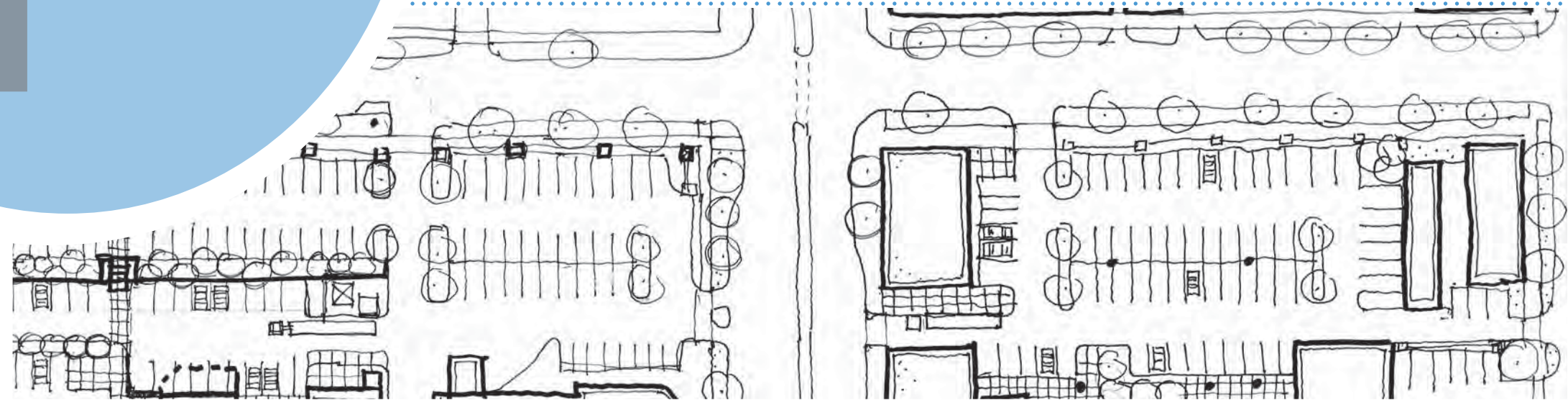

Parking Solutions for the Central Corridor

PARKING SOLUTIONS WORKSHOP SUMMARIES

October 2009



Presented by the Parking Solutions Team of the Central Corridor Project Office, the City of St. Paul Department of Planning & Economic Development, and the Central Corridor Design Center

Contact: Neighborhood Commercial Parking Program
ATTN: Craig Blakely, Dept of Planning and Economic Development
25 West Fourth Street, 13th Floor, Saint Paul, Minnesota 55102



Parking Solutions for the Central Corridor

INTRODUCTION AND GUIDELINES FOR THE PARKING SOLUTIONS WORKSHOP SUMMARIES

TABLE OF CONTENTS & WORKSHOP STUDY AREAS ALONG THE CENTRAL CORRIDOR

| | |
|------|--|
| Page | |
| 1-2 | Introduction |
| 3-4 | Raymond to Highway 280 and Franklin, North and South (A) |
| 5 | Transfer to Vandalia, North Side (B) |
| 6 | Fry to Aldine, North Side (C) |
| 7 | Simpson to Fry, North Side (D) |
| 8 | Albert to Pascal, North Side (E) |
| 9 | Lexington to Dunlap, North Side (F) |
| 10 | Grotto to Victoria, South Side (G) |
| 11 | Kent to St. Albans, North Side (H) |
| 12 | Arundel to Mackubin, South Side (I) |
| 13 | Western to Arundel, North Side (J) |
| 14 | Galtier to Western, North Side (K) |
| 15 | Parking Guidelines |
| 16 | Commercial Parking Program Application |



Program Purposes: The primary purpose of the Neighborhood Commercial Parking Program is to help mitigate the loss of 85% of the parking on University Avenue when LRT is developed. Other purposes are to demonstrate the ability of integrated parking improvement and management strategies to increase the amount and utilization of commercial parking, and to encourage business and property owners to equitably share the use and operating costs of off-street parking.



Introduction: From May 20th to August 13th, 2009, 11 parking workshops were held with property and business owners and Central Corridor Project Office, City of Saint Paul, and Central Corridor Design Center staff at the Central Corridor Resource Center. The participants in these workshops represented properties and businesses located in one of the 11 “critical areas” along University Avenue identified in the report, *Mitigating the Loss of Parking in the Central Corridor*, as being substantially impacted by the loss of 85% of the on-street parking due to light rail construction.

The goal of these workshops was to identify potential shared parking and design solutions to mitigate the loss of on-street parking for the businesses represented. Participants at the workshops described parking, delivery, and waste issues necessary for the operation to their business. Staff used this input to develop drawings of potential improvements to make off-street parking more efficient, create better access, and provide stormwater treatment. In many cases, staff was able to create designs for additional parking spaces and in all cases the parking was designed to be inviting for patrons to use.

The outcome of each workshop is documented in the illustrations on the following pages. The illustrations are conceptual and preliminary in nature. Final designs will vary based on the number of property owners involved, unforeseen site constraints, and business owners’ desires. Participants are encouraged to use these drawings to develop ideas for parking improvements and to use these ideas to apply for the Neighborhood Commercial Parking Program (NCP). (Application attached)

Program Framework

Process

How We Got Here: The city has worked towards developing a planning and development strategy for the Central Corridor. Prior to the parking report, the CC Development Strategy, 7 Station Area Plans, and the business survey led to the creation of the parking report by the city and the Met Council. All documents are available on the City of St. Paul Central Corridor website.

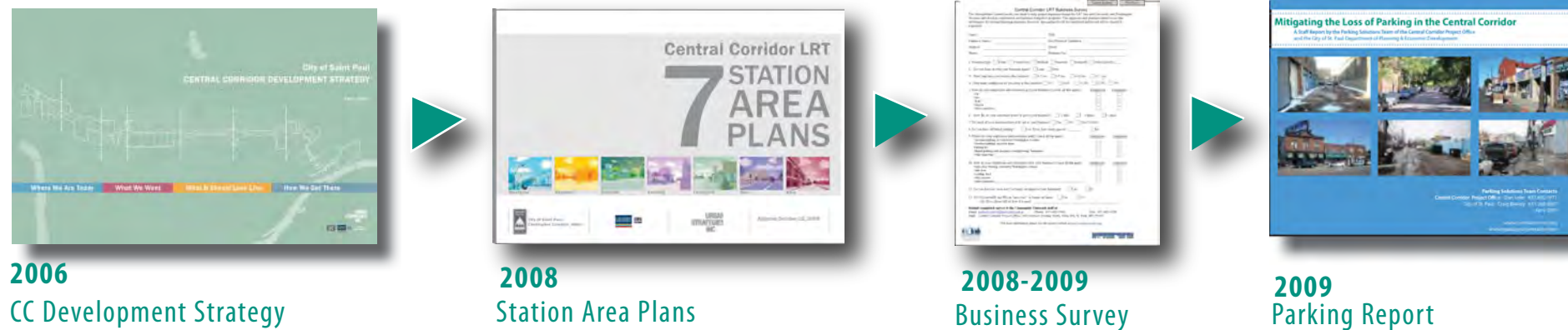

Next Steps: Property and business owners who are in critical areas or are substantially impacted by the loss of on-street parking are eligible and encouraged to apply to the Neighborhood Commercial Parking Program. Forgivable loans up to \$25,000 will be available to individuals and larger loans will be available for those willing to enter into a shared parking agreement and submit a joint program application. Sites within the 11 critical parking areas identified in the "Mitigating the Loss of Parking in the Central Corridor" report will be given priority. The application form is attached at the end of this document.

Eligible Improvements and Costs:

- Curb cuts
- Paving
- Walls and fences
- Garages - repairing or removing garages
- Security improvements
- Accessibility
- Pedestrian improvements
- Landscaping
- Stormwater management
- Refuse facilities



This photo of a parking lot in Portland, OR illustrates many of the design guidelines (above, right) used to develop the parking workshop illustrations.

Design

Design Guidelines: Design guidelines are described in detail after the workshop summaries. In general, the following design principles were considered when creating the conceptual illustrations:

- Alley Redevelopment for Improved Circulation
- Integrated Landscaping and Stormwater Management
- Alley Redevelopment for Additional Parking
- Planning Module for Parking Dimensions
- Interior Block Access and Amenities
- Stabilize the Alley Edge

Design Principles: From the Central Corridor Development Strategy

1. Reposition St. Paul in the Region
2. Benefit and Strengthen the Diverse Communities Along the Corridor
3. Link and Foster Economic Activity
4. Improve People's Mobility Throughout the Community
5. Improve the Image and Quality of Life along the Corridor
6. Collaborate from Design to Operation

Design Parameters and Limitations: The designs shown are meant to be illustrative and show one of many possible solutions. It was assumed that all property owners would need to cooperate on a new design. The designs were intended to balance parking efficiency, pedestrian safety and accessibility, and stormwater treatment. Zoning requirements were applied generally to the design, but would need further review on a case by case basis. Actual designs submitted to the NCPP will vary from the illustrations based upon the number of properties involved, business needs, project budget, land uses, and zoning requirements as applied to the specific design.

P Raymond Avenue to Highway 280, north side

Parking Workshop 11 - 08.13.2009

Parking Solutions Concept Plan:

The big idea for this area is to reconfigure the Charles/Raymond intersection to create a multi use parking facility and market square. Existing parking is also reconfigured in a more efficient manner.



Potential Parking Solutions

1. Shared Parking Opportunities

1A. Shared Parking - Alleyway Parking

- Additional row of parking is possible with a more efficient lot to the south
- About 38 additional spaces possible

1B. Shared Parking - Raymond/Territorial NW Corner Shared Lot

- Extend rows of recently improved lot north into undeveloped lot
- Creates about 43 spaces and improves internal circulation

1C. Shared Parking - Internal Shared Lot, Western Block

- Design builds on recent improvements
- Coordinated design improves circulation, efficiency, and makes parking an amenity to users

1D. Shared Parking - Internal Shared Lot, Eastern Block

- Allows for better circulation and additional spaces

2. New Farmer's Market-style Flexible Parking Area

- New intersection would be created to provide more on-street parking

3. Travel Demand Management

- Encourage the use of mass transit

4. LRT Station

5. Permit Parking

- Employees should be considered in this permit system to relieve spaces closer to businesses

6. Provide Accessible Walkways to Parking

- Improve ADA access to building fronts

- Make parking behind buildings more accessible, safe, and attractive

7. Multi-use Accessways

- Provides off-street space for deliveries, emergency access, pedestrians, and sidewalk cafes/patios

8. Corner Bump-outs

- Shortens crossing distance for pedestrians and gives visual cue for on-street parking

Workshop Participants

Nate Kuehl - US Bank
 Jim Forsland - Sharretts Liquors
 Peter Brown - Security Building
 Andre Opitz - Budget Sign
 Bill Miller - Twin City Bank Building
 Mary Leonard - Chocolat Celest
 Joesph Ring - Prospect Park
 Susan Thrash - Prospect Park

Jack McCann - Midtown Commons
 Barbara Hunn - Keys Restaurant
 Bob Slater - Surplus Office Supply
 David Nemo - Picture Frame Supply
 Sandy Jacobs - Update Company
 Jon Commers - St. Anthony Park
 Patricia Ya Ya - The Edge Coffee House

key

- parking- new or reconfigured
- paved area- limited vehicle use
- paved area - pedestrian use
- buildings
- private land
- landscape or stormwater opportunity
- street tree - not to scale
- ▲ new or relocated curb cut
- △ existing curb cut to remain

P Raymond Avenue to Highway 280, south side









Parking Workshop 11 - 08.13.2009



Parking Solutions Concept Plan:

The concept diagram illustrates the recommended parking solutions concepts. The big idea is to reorganize and expand the existing parking lots to create shared or managed parking opportunities. Street parking is also increased and can be managed by meters and permits to provide adequate parking solutions for employees and for customers.

key

-  parking- new or reconfigured
-  paved area- limited vehicle use
-  paved area - pedestrian use
-  buildings
-  private land
-  landscape or stormwater opportunity
-  street tree - not to scale
-  new or relocated curb cut
-  existing curb cut to remain

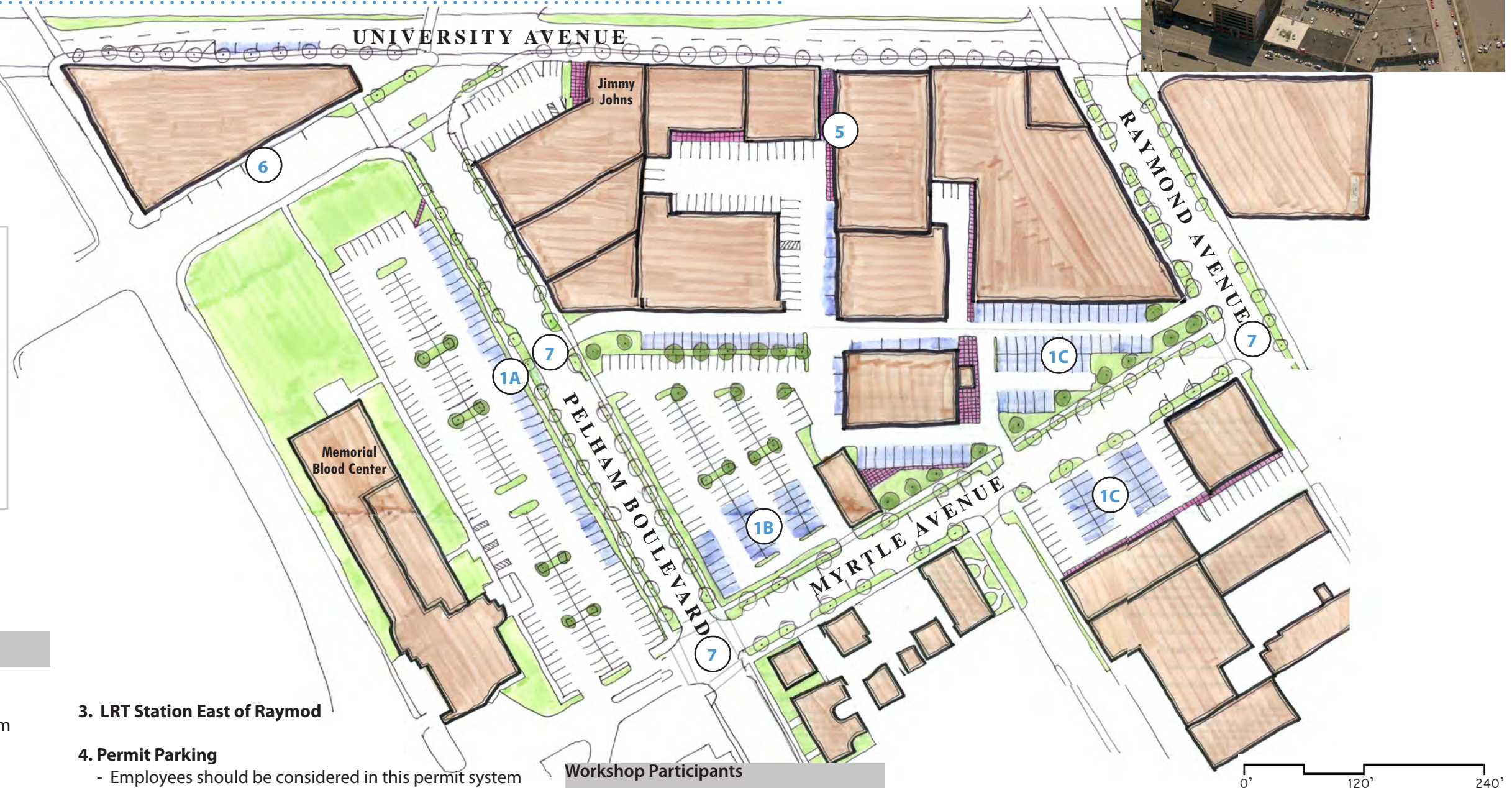

Potential Parking Solutions

1. Shared Parking Opportunities

1A. Shared Parking - Lot West of Pelham

- Elongated row of parking is possible along Pelham
- About 42 additional spaces possible

1B. Shared Parking - NE Corner of Pelham/Myrtle

- Vacant lot could be added to parking
- Creates about 31 spaces and improves internal circulation

1C. Shared Parking - NW and SW Corners of Myrtle/Raymond

- Reconfigure lots to improve circulation, efficiency, and add a few more spaces

2. Travel Demand Management

- Encourage the use of mass transit

3. LRT Station East of Raymond

4. Permit Parking

- Employees should be considered in this permit system to relieve spaces closer to businesses

5. Provide Accessible Walkways to Parking

- Improve ADA access to building fronts
- Make parking behind buildings more accessible, safe, and attractive

6. New On-street Spaces Due to LRT Construction

7. Corner Bump-outs

- Shortens crossing distance for pedestrians and gives visual cue for on-street parking

Workshop Participants

- Nate Kuehl - US Bank
- Jim Forsland - Sharretts Liquors
- Peter Brown - Security Building
- Andre Opitz - Budget Sign
- Bill Miller - Twin City Bank Building
- Mary Leonard - Chocolat Celest
- Joesph Ring - Prospect Park
- Susan Thrash - Prospect Park
- Jack McCann - Midtown Commons Building
- Barbara Hunn - Keys Restaurant
- Bob Slater - Surplus Office Supply
- David Nemo - Picture Frame Supply
- Sandy Jacobs - Update Company
- Jon Commers - St. Anthony Park
- Patricia Ya Ya - The Edge Coffee House

P Transfer Road to Vandalia Street, north side

Parking Workshop 8 - 07.23.2009



Parking Solutions Concept Plan:

The concept diagram illustrates the recommended parking solutions concepts. On this block, 12 on-street parking spaces will be lost due to LRT construction. The concept for this block is to reestablish Charles Street at the north to utilize the existing ROW and to give a boundary to the block. The internal driveways are re-designed to create clear paths for vehicular access, but in such a way that will manage speed and safety. The block is predominantly under single ownership, presenting great redevelopment opportunities.

Potential Parking Solutions

1. Reorient and Reorganize Current Parking Lots

- Parking lot islands for green space and stormwater
- Empty buildings can be reused for covered parking

2. Re-establish Charles Street on North Edge of Properties

- Establish a curb so that trucks will not block access to parking areas

3. Shared Parking

- Establish areas along east side of Subway for truck and trailer parking during rush business hours.
- Remove barriers between parking lots

4. Reduce Curb Cuts

- Curb cut at the southeast corner of the block should be moved back from the intersection
- Curb cut west of the subway building to have limited use for deliveries

5. Provide Accessible Walkways

- Various locations, especially new shared parking, would benefit from added pedestrian pathways leading to and from University Avenue
- Pathways should be ADA accessible, well-lit and landscaped to encourage better use of the off-street parking

6. Shared Refuse and Recycling

- Commercial buildings should work with the Minnesota WasteWise Program to consider consolidating dumpsters and recycling



7. Deliveries and Loading

- Work with vendors to schedule most deliveries before 11am or after PM traffic peak (6pm) when there is the least congestion
- Stop in right through-lane of University Avenue
- Explore strategies for ADA accessible loading
- Keep deliveries in the alley short to provide for good internal circulation and access to customer parking

8. Establish Clear Pathways that Control Internal Traffic

- The roundabout and bend in the road will reduce cut-through traffic

9. Enforce Short-term On-street Parking on Side Streets

- Time-limited, not metered
- One-hour near University

key

- | | | |
|---------------------------------|-------------------------------------|-----------------------------|
| parking- new or reconfigured | landscape or stormwater opportunity | new or relocated curb cut |
| paved area- limited vehicle use | buildings | existing curb cut to remain |
| paved area - pedestrian use | street tree - not to scale | |

Workshop Participants

- Scott Huest** - DS&B Realty
Peter Vento - Classic Retro Company
Jackie & Jeff Lunde - Subway
Bob Pankonin - SPI Printing

P Fry Street to Aldine Street, north side

Parking Workshop 3- 06.01.2009



Parking Solutions Concept Plan:

The map to the right illustrates the recommended parking solutions concepts. On this block, nine on-street parking spaces will be lost due to LRT construction. The concept for this block is to reorganize the existing parking within the area of change to provide a clear circulation route throughout the block and to create opportunities for shared parking lots. This approach requires minor adjustments to an already compact parking pattern with owner cooperation.

- key**
- parking- new or reconfigured
 - paved area- limited vehicle use
 - paved area - pedestrian use
 - buildings
 - private land
 - landscape or stormwater opportunity
 - street tree - not to scale
 - new or relocated curb cut
 - existing curb cut to remain

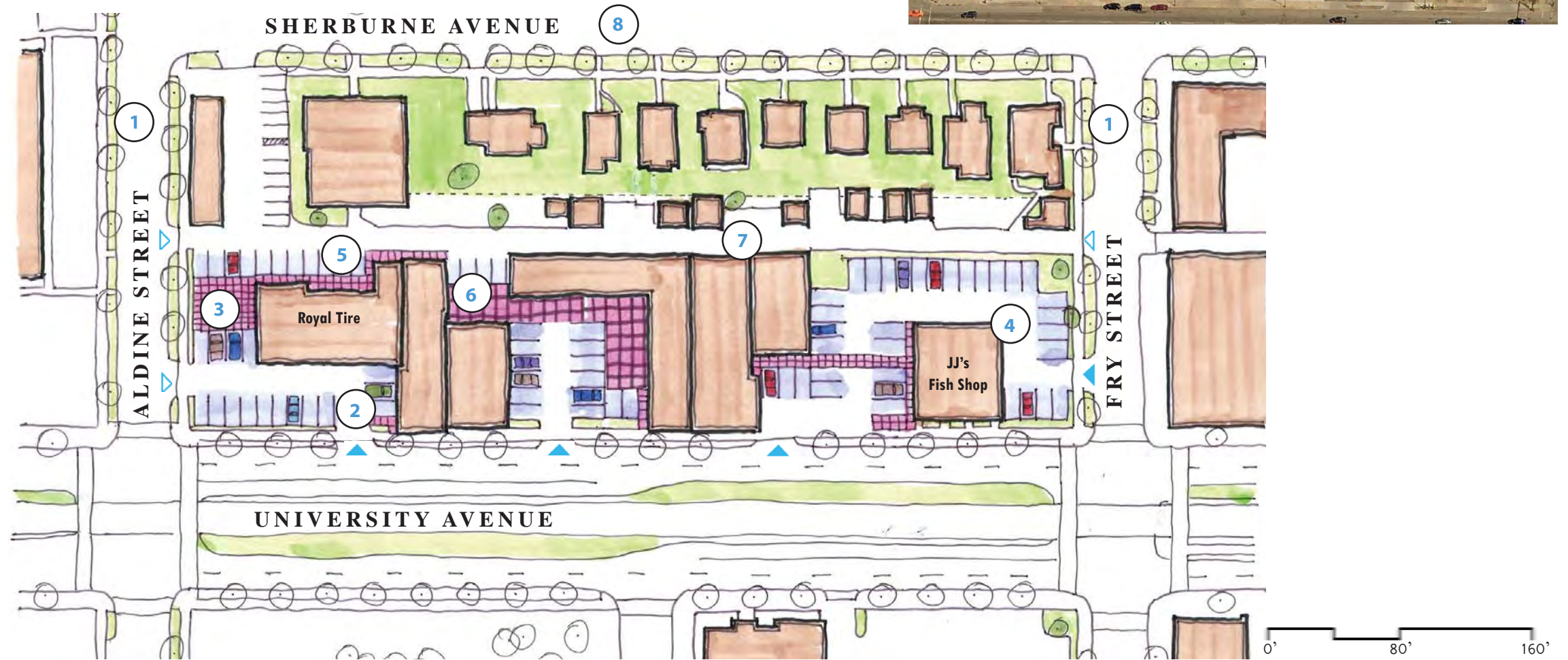

Potential Parking Solutions

1. On-street Parking

- One-hour parking on Aldine will prevent "hide and ride" activity and serve short-term needs of several businesses
- Metered parking will remain on the block on University just west of Aldine, serving some needs of businesses on this block
- Fry should continue to have one-hour parking to increase turnover of spaces for businesses

2. Deliveries to Royal Tire Lot

- Keep diagonal curb cut on University to help delivery trucks to enter the lot easily
- Parking lot will be one-way, entering on University, to improve circulation and facilitate deliveries
- Allow loading and deliveries to continue to happen near the front doors of the businesses

3. Car Stacking in Royal Tire Lot

- Employees, or cars being serviced at Royal Tire, can be stacked, or parked in tandem, to create additional parking in the existing space

4. Shared parking in JJ's Fish & Chicken Lot

- Reconfigure parking in existing lot to maximize spaces
- Remove redundant curb cuts that may result in additional space for off-street parking

5. Recycling

- Reclaim parking space currently used for storing tires
- Create a more efficient cage system to hold tires waiting for recycling pick up
- Use a recycling program with frequent pick up so that fewer tires are needed to be stored on-site
- An improved cage could sit on the low ledge along the alley that can not be used for parking

6. Lot behind Regina Vacuum

- Clean up small parking area and improve rear access to building
- Repave area with pervious pavers and limit vehicular use of paved area

7. Alley Clean-Up

- Remove brush in the alley to improve circulation and gain width
- Use Youth Job Corps program for summer alley clean-up

8. Residential and Employee Permit Parking

- Permit Parking should be studied for use north of the block
- Employees should be considered in this permit system to relieve spaces closer to businesses

Workshop Participants

- John Reiter** - Regina Vacuum
- Steve Bernik** - Milburn Clothing

P Simpson Street to Fry Street, north side

Parking Workshop 9 - 07.30.2009

SNELLING STATION AREA

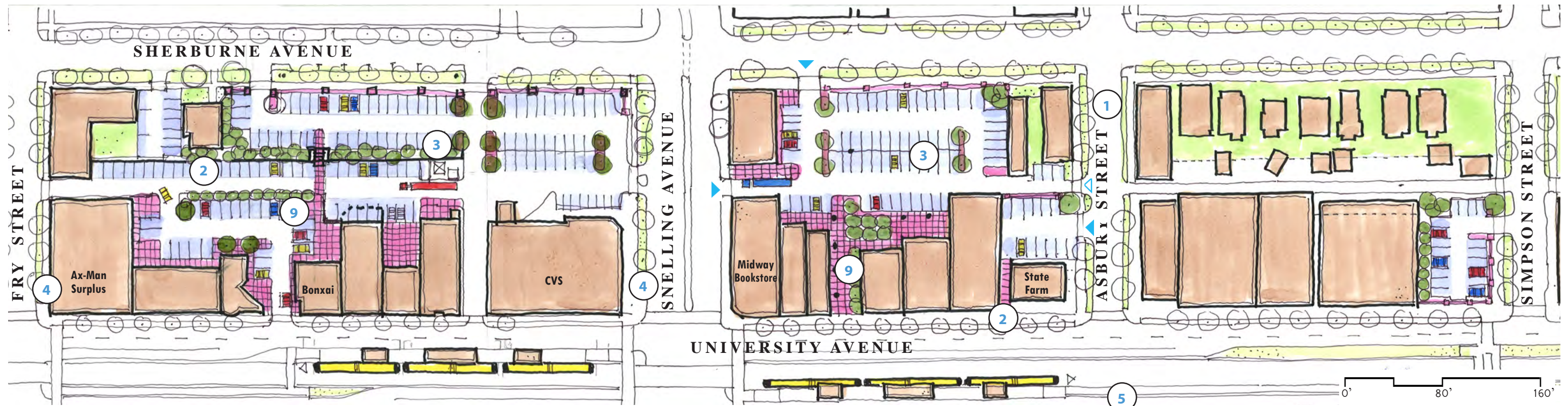

Parking Solutions Concept Plan:

The map above illustrates the recommended parking solutions concepts. Within this area, 18 on-street parking spaces will be lost due to LRT construction. The overall approach for the parking solutions is to create large shared parking lots with secure entrances. All parking lots will employ CPTED principles to increase safety.

key

- parking- new or reconfigured
- paved area- limited vehicle use
- paved area - pedestrian use
- landscape or stormwater opportunity
- buildings
- private land
- street tree - not to scale
- new or relocated curb cut
- existing curb cut to remain

Potential Parking Solutions

1. Manage parking on Fry and Asbury

- One or two hour meters on Asbury
- Preserve on street parking for customers
- Enforce time-limited signage on Fry

2. Deliveries and Loading

- Stop in right through-lane of University Avenue
- Work with vendors to schedule most deliveries before 11AM or after PM traffic peak (6PM) when there is the least congestion
- Explore strategies for ADA accessible loading
- Keep deliveries in the alley short to provide for good internal circulation and access to customer parking

3. Security and Personal Safety

- Lighting, new pedestrian walkways
- More visibility of security - bike police patrol, or Metro Transit police, private security guard

- Crime Prevention Through Environmental Design (CPTED) - use this block to pilot LRT personal safety measures. CPTED design group should make suggestions based on issues brought up during the parking workshop
- Paid parking booth/arm to reduce vandalism, increase visibility and management
- Explore the addition of back doors and windows on businesses to increase visibility

4. Bike Parking

- Add hitch-style racks on University Avenue and Fry Street (explore the use of Public Works program that shares the cost and assumes maintenance of bike racks in the public right-of-way)
- Opportunity for bike lockers at Snelling - near the existing bus shelter next to CVS
- Expand secure and covered bike parking at Spruce Tree Ramp

5. Traffic Issues and Congestion

- Close traffic median on Snelling at alley south of Sherburne to prevent dangerous southbound left turns
- Create improved and legible pedestrian and automobile circulation within each block

6. Bus Stops

- Explore improvements to bus waiting areas on Snelling north of University, including moving the stop, expanding the sidewalk, or removing the bus shelter

7. Spruce Tree Ramp and other remote parking

- Spruce Tree has the ability to build additional stories
- JJ's Fish and Chicken has underutilized parking that could serve businesses from Aldine to Snelling
- Southeast corner of Fry and University - future "Saint Paul Credit Union" site - short term (2-3 years) shared parking lease to help businesses during construction

- Advertise existing shared parking agreements (e.g. Turf Club has shared parking at Spruce Tree Ramp)

8. Maintenance

- Enforcement of existing snow clearing regulations
- Arrange lease agreements that are easy to maintain, and that are legally binding

9. Provide Accessible Walkways to Parking

Workshop Participants

- Kathy Stransky** - Midway Bookstore
- Tina Lehman** - Metro Dental Care
- Jim Segal** - Ax-Man Surplus
- Doug and Alen Nguyen** - State Farm Insurance
- Beth Mahalla** - American Bank
- Tim Holden** - Added Value Improvements
- David Grag** - 1607 University Avenue

P Albert Street to Pascal Street, north side

Parking Workshop 6- 07.01.2009



Parking Solutions Concept Plan:

The map to the right illustrates the recommended parking solutions concepts. On this block, 15 on-street parking spaces will be lost due to LRT construction. The proposal for this block is to utilize the available spaces for shared parking lots arranged with legal agreements between property owners. The concept plan also suggests improved circulation throughout the block by adding one curb cut and keeping the alley way clear for vehicles and delivery trucks.

key

- parking- new or reconfigured
- paved area- limited vehicle use
- paved area - pedestrian use
- buildings
- private land
- landscape or stormwater opportunity
- street tree - not to scale
- new or relocated curb cut
- existing curb cut to remain

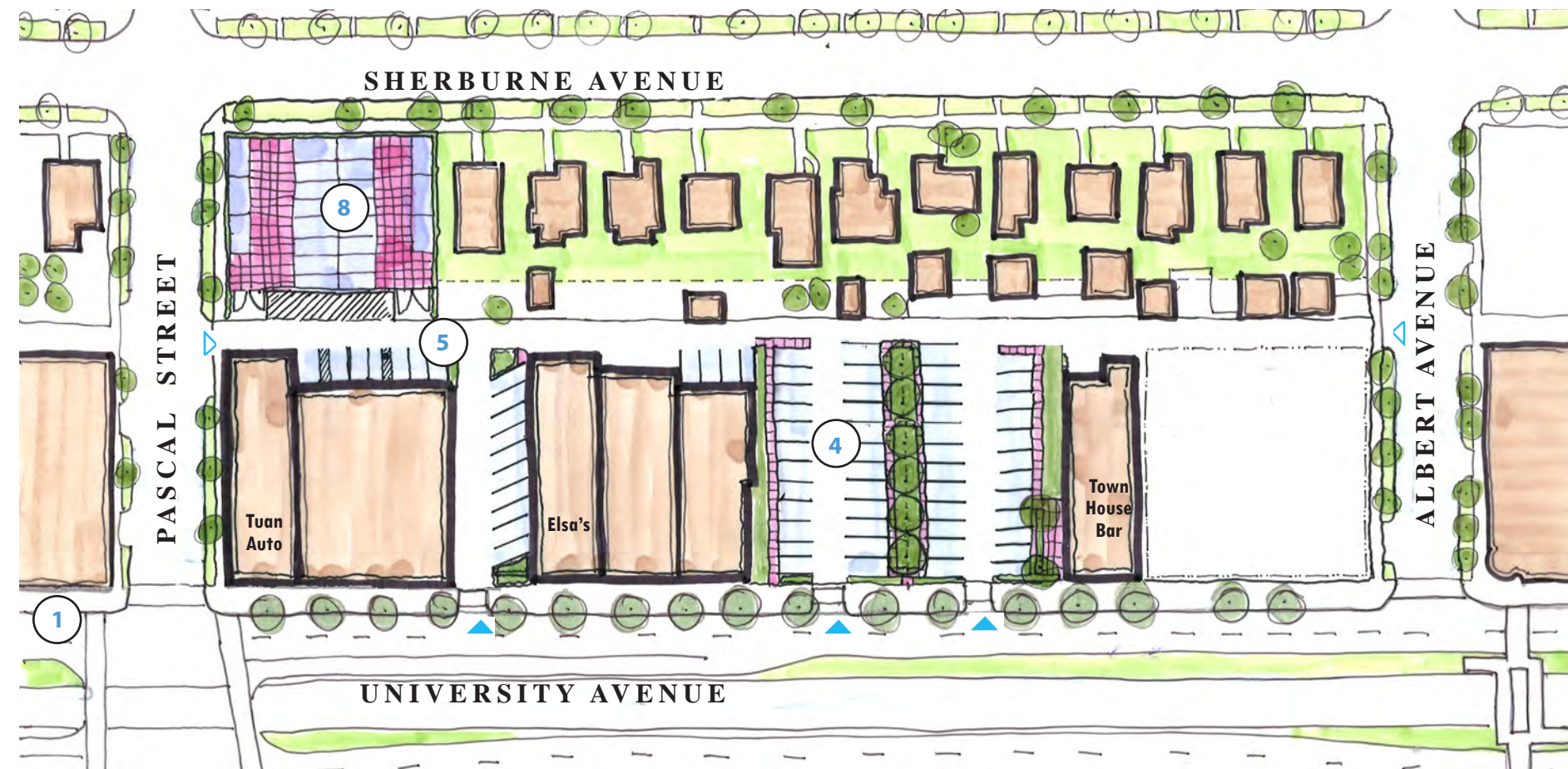

Potential Parking Solutions

1. Explore Shifting the Location of the Bus Stop at Pascal (Westbound) to the Far Side of the Intersection

- Improve circulation and turning northbound onto Pascal

2. Side Street Parking and Deliveries

- Maximize and manage parking for customers 1 block north and south of University on Albert and Pascal
- Minimize large driveways on side streets
- Off-peak deliveries may be made in the right lane of University Ave before 11 am, after 6 pm
- Quick Drop-off/pickup on side streets needed
- Time limited parking can encourage turnover
- Explore major barriers to getting vendors to change delivery times – coordinate with neighbors or other customers on University

3. LRT Station at Hamline

- Detailed station area planning needed
- Hamline station should be built to improve access between Snelling and Lexington

4. 1433 Lot – Shared Parking

- During construction, multiple businesses could lease this space as shared off-street parking
- Needs restriping and signage
- Long-term redevelopment will shape parking supply and demand on the block
- Design lot for potential lot split and sale
- Potential for metered/regulated spaces to serve different kinds of demand
- Work with Townhouse Bar to explore options for an outdoor patio on this property

5. Redesign East Side of Block for Better Circulation Increased Parking and Improved Loading

- New driveway to improve circulation
- Move diagonal parking to east side
- New loading zone to be added as a short term solution
- Add curb cut on University to provide better circulation

6. Consolidate Recycling/Refuse

- Reduce containers behind businesses – consolidate where possible
- Use Minnesota Wastewise program to help coordinate and evaluate strategies

7. Remote Parking for Employees/Long-term Visitors

- Seek underutilized property on adjacent blocks for long-term parking during the day and high volume parking at night for Townhouse Bar
- Lighting – side streets and parking lots – add additional pedestrian scale lighting for safety and comfort

8. Explore Development of Shared Parking Ramp at Tuan's Auto

- Secure parking for Tuan's Auto
- Allow for future transit-oriented development
- Redesign current lot for organized parking with flexible space for overflow parking

0' 80' 160'

Workshop Participants

- Ultan Dugan** - 1447-1455 University Ave
- Thu Pham** - Tuan Auto
- Mike Finkelstein** - Midway Chevrolet/Ackerberg Group
- Tetra Canstantino** - Elsa's House of Sleep

P Lexington Parkway to Dunlap Street, north side









Parking Workshop 5 - 06.10.2009



Parking Solutions Concept Plan:

The map illustrates the recommended parking solutions concepts. On this block, 13 on-street parking spaces will be lost due to LRT construction. Parking is reorganized in this concept, to efficiently use space and create shared parking areas with space for pedestrian access, landscaping, and stormwater management. This scheme also encourages reconfiguration of the alley for joint uses including parking, deliveries, and waste management.

key

-  parking- new or reconfigured
-  paved area- limited vehicle use
-  paved area - pedestrian use
-  buildings
-  private land
-  landscape or stormwater opportunity
-  street tree - not to scale
-  new or relocated curb cut
-  existing curb cut to remain

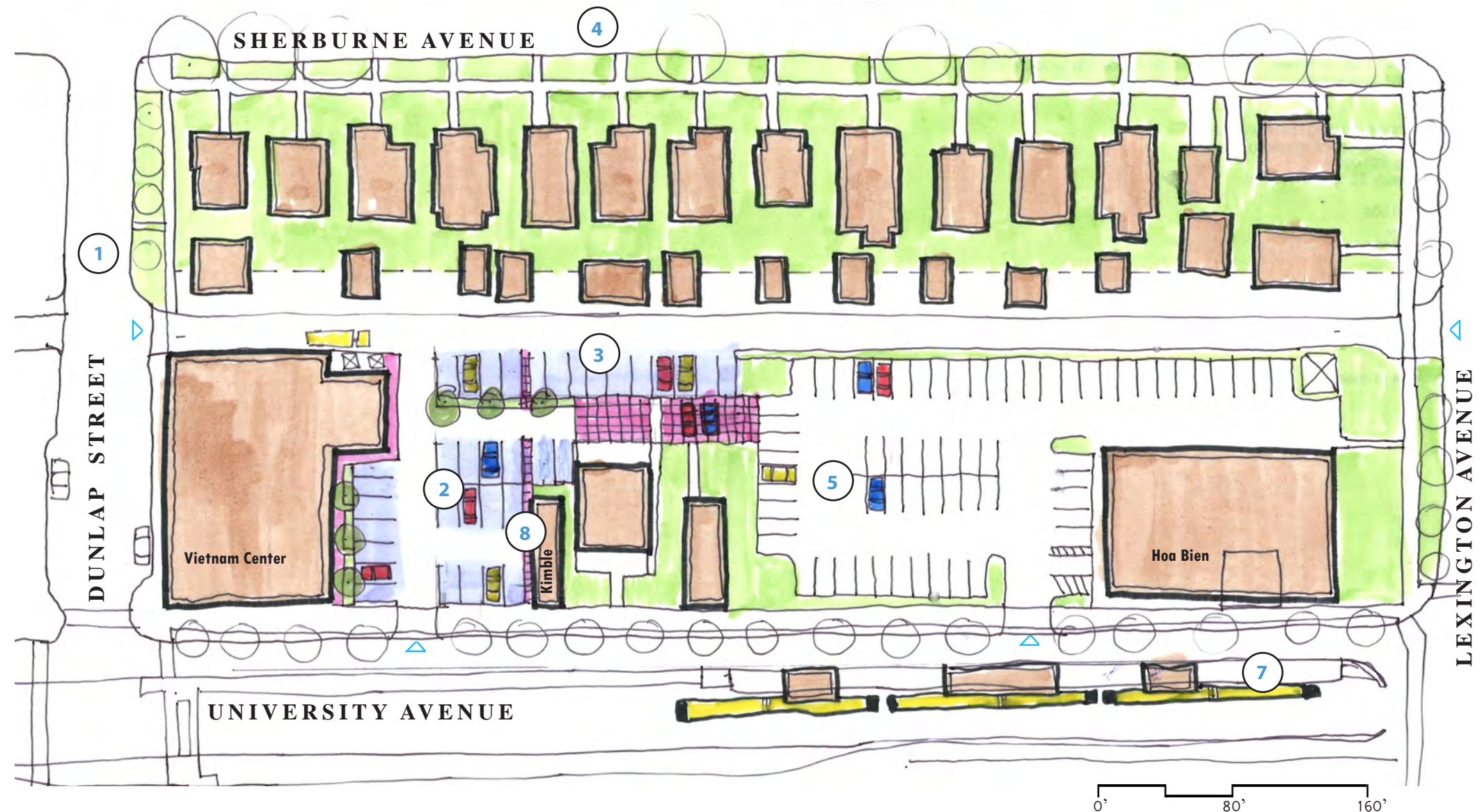

Potential Parking Solutions

1. Enforce Short-term On-street Parking

2. Create Shared Parking Opportunities at Vietnam Center & Kimble Chiropractic Offices

- Signing for use by multiple businesses
- Create an alley opening to improve circulation
- Create a formal shared parking agreement between property and business owners
- New striping could add one space to Vietnam Center lot and two spaces to Kimble and would provide easier access to both
- Vietnam Center could discontinue informal "valet" system with more efficient parking lot design

3. Reconfigure Parking Behind Twin City Monument & Residential Property

- Continuous row of parking would provide maximum number of spaces
- Formalize stacked employee/truck parking behind Twin City Monument to maximize efficiency

4. Permit Parking

- Permit Parking should be studied for use north of the block
- Employees should be considered in this permit system to relieve spaces closer to businesses

5. Continue Shared Parking between Vietnam Center & Hoa Bien Restaurant during Special Events

- The two lots can be complimentary for special events at the Vietnam Center during the weekdays, and at Hoa Bien during the weekends.

6. Travel Demand Management

- Encourage the use of mass transit with Metro Pass

7. LRT Station at Lexington

8. Provide Accessible Walkways to Parking

- Improve ADA access to building fronts
- Make parking more accessible, safe, and attractive

Workshop Participants

Phan Nguyen - Vietnam Center & Vietnam Social Services

P Victoria Street to Grotto Street, south side

Parking Workshop 2 - 05.28.2009

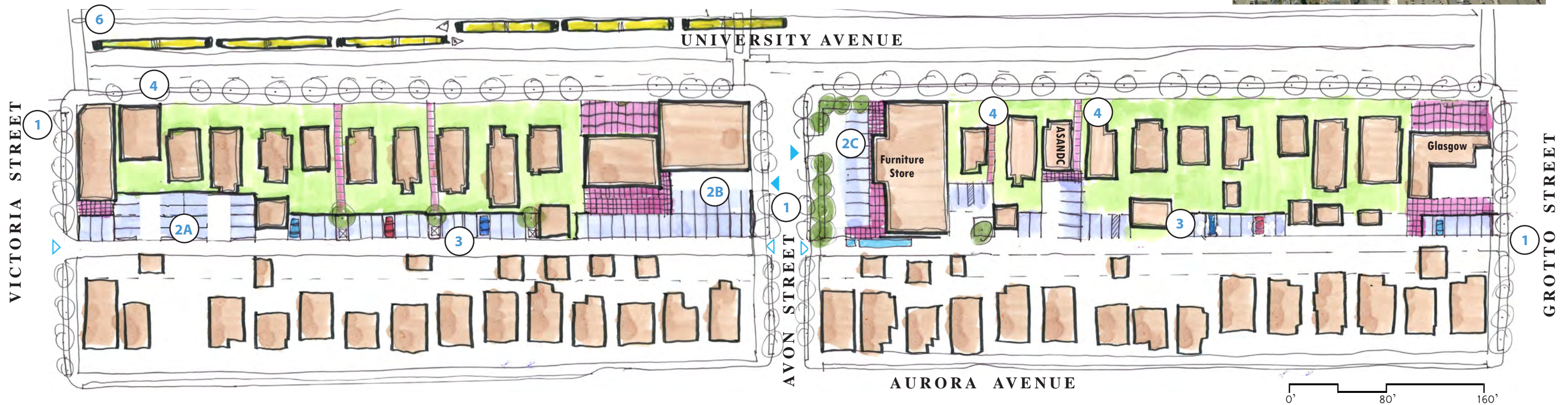

Parking Solutions Concept Plan:

The map above illustrates the recommended parking solutions concepts. On this block, 33 on-street parking spaces will be lost due to LRT construction. The concept for these blocks is to utilize the alleyway as a secondary access route to the businesses on University Avenue for parking, deliveries, and waste management. Parking is organized off the alleyway for residential blocks evolving into a mix of commercial and residential use.

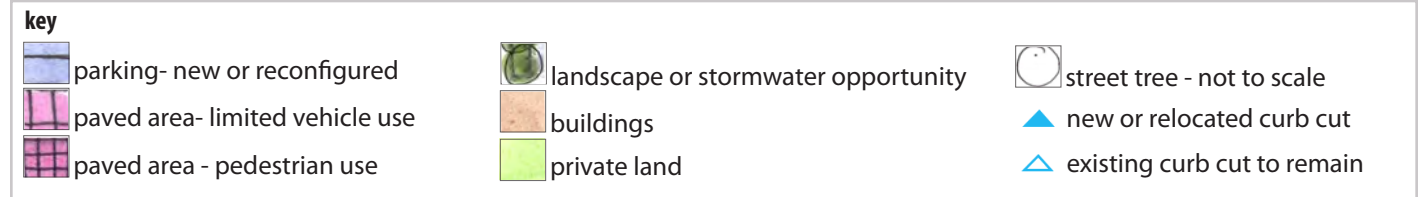

Potential Parking Solutions

1. Time-limited On-street Parking

- Two-hour time-limited signage on Victoria to prevent "hide & ride" and all-day parking
- One-hour time-limited signage on Avon to serve short-term needs for the two grocery stores
- Two-hour time-limited signage on Grotto to serve Breaking Free, ASANDC meetings
- Metered parking between Avon and Grotto on the north side of University, serving some needs of businesses on this block.

2. Create Shared Parking Opportunities

2A. Shared Parking - "Winston" Shared Lot

- Remove garage, reconfigure off-street parking for shared use

2B. Shared Parking - "Groceries" Shared Lot

- Cater to short-term parking demand
- Potential for new shared access off the alley
- May regain some on-street parking on Avon due to reconfiguration of driveway

2C. "Furniture Store" Shared Lot

- Different peak hours make sharing feasible
- Restripe to improve efficiency and circulation

3. Residential Parking Band

- Nose-in (perpendicular) parking off the alley - either surface or garage (where they exist)
- Improve existing conditions and increase space for residents and their guests

4. Walkways to University

- Improve ADA access to building fronts
- ASANDC pathway is a model
- Make parking behind buildings more accessible, safe, and attractive

5. Travel Demand Management

- Encourage the use of mass transit

6. Infill LRT Station at Victoria

Workshop Participants

- Mike Glasgow** - Glasgow Automotive Service
- Claire Glenn** - Breaking Free
- Pat Black** - Aurora St. Anthony Neighborhood Development Corporation
- Dennis Presley** - Aurora St. Anthony Neighborhood Development Corporation
- Mai Her Lee** - Star Oriental Market
- Ali Yusuf** - Halal Meat Express
- Winston Le** - Tai Hoa & Translation Service
- Mahmud Abbajefar** - Ashama Auto

P Kent Street to St Albans Street, north side

Parking Workshop 7- 07.15.2009

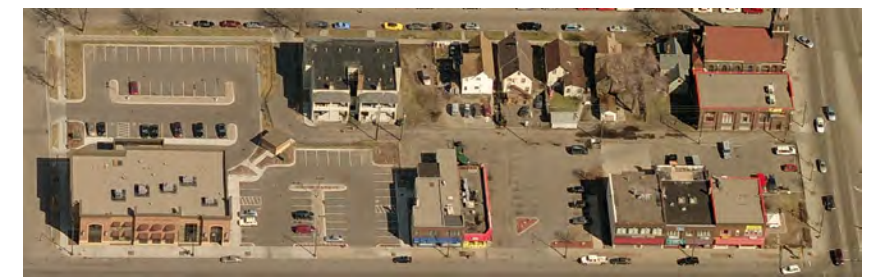

Parking Solutions Concept Plan:

The map illustrates the recommended parking solutions concepts. Parking on this block is reconfigured to use the alley as an access way for parking and for delivery vehicles. Landscaping and pedestrian pathways are integrated into this block for shared parking opportunities and improved internal block circulation.

key

- parking- new or reconfigured
- paved area- limited vehicle use
- paved area - pedestrian use
- buildings
- private land
- landscape or stormwater opportunity
- street tree - not to scale
- new or relocated curb cut
- existing curb cut to remain

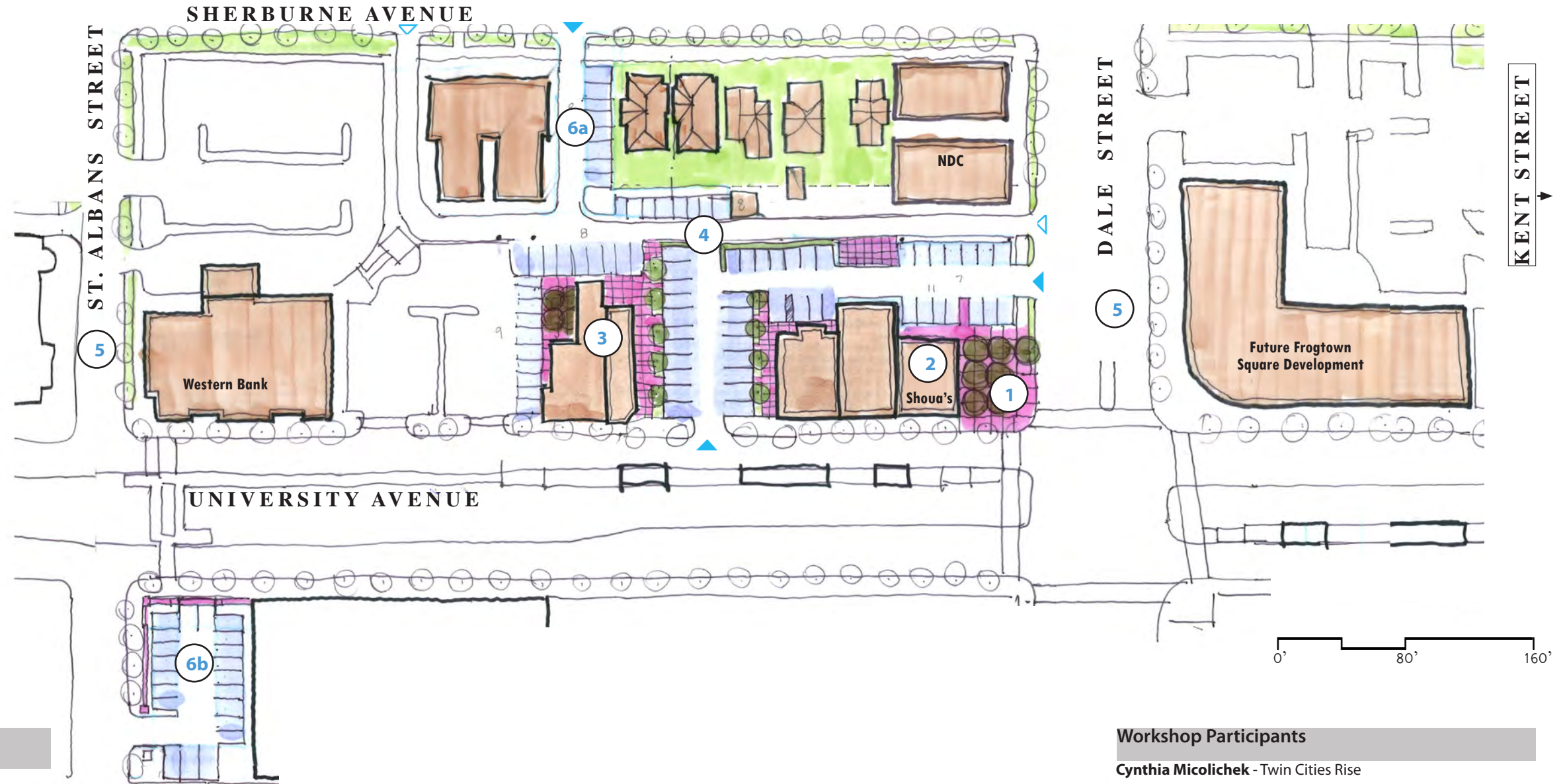

Potential Parking Solutions

1. University and Dale Pocket Park

- City owned pedestrian space on the vacant land at University and Dale is a potential green space

2. 625 University Avenue - Shoua's Clothing Shop, NDC, Vacant Restaurant

- Improve the rear door to be ADA accessible and to improve safety with a view in/out of the rear door and adequate lighting
- Provide pedestrian access to University Ave via the City-owned pedestrian space
- Consolidate dumpsters, trash, and recycling

3. Twin Cities Rise and Hickory Hut

- Repair the parking lot and alley area
- Move access for the curb cut for better traffic flow

- Provide managed tandem parking for staff
- Consolidate dumpsters and consult Waste Wise & other innovative waste programs
- Remove fence behind Spectrum Services for parking and pedestrian access to back and side doors of Hickory Hut and Spectrum Services

4. Alley Improvements

- Repave the alley, consider making it one-way, and widen
- Explore relocating/consolidating the utility poles
- Provide pedestrian walk-ways to the businesses on University Avenue

5. Utilize and Manage Side Street Parking

6. Shared Parking Opportunities

6a. Shared Parking - Vacant Sherburne Lot

- Utilize the Empty Lot facing Sherburne Avenue for commercial parking, particularly for employee parking

6b. Shared Parking- University and St. Albans Street

- City owned lot should be developed to serve public parking needs in the surrounding blocks.

Workshop Participants

Cynthia Micolich - Twin Cities Rise

Tom McKay - Spectrum Staffing

Shoua Thao - Shoua's Clothing Shop

Mike Lataro - Neighborhood Development Center

Sia Lo - Greater Frogtown CDC and Frogtown Square

P Arundel Street to Mackubin Street, south side

Parking Workshop 10 - 08.06.2009



Parking Solutions Concept Plan:

The diagram illustrates the recommended parking solutions concepts. On this block, 6 on-street parking spaces will be lost due to LRT construction. The concept for the block is to reestablish the alley way as a usable corridor for internal circulation, building access, and service vehicles. Ultimately, this will improve the safety of the block and increase supervision of alley activities.

key

- parking- new or reconfigured
- paved area- limited vehicle use
- paved area - pedestrian use
- buildings
- private land
- landscape or stormwater opportunity
- street tree - not to scale
- new or relocated curb cut
- existing curb cut to remain

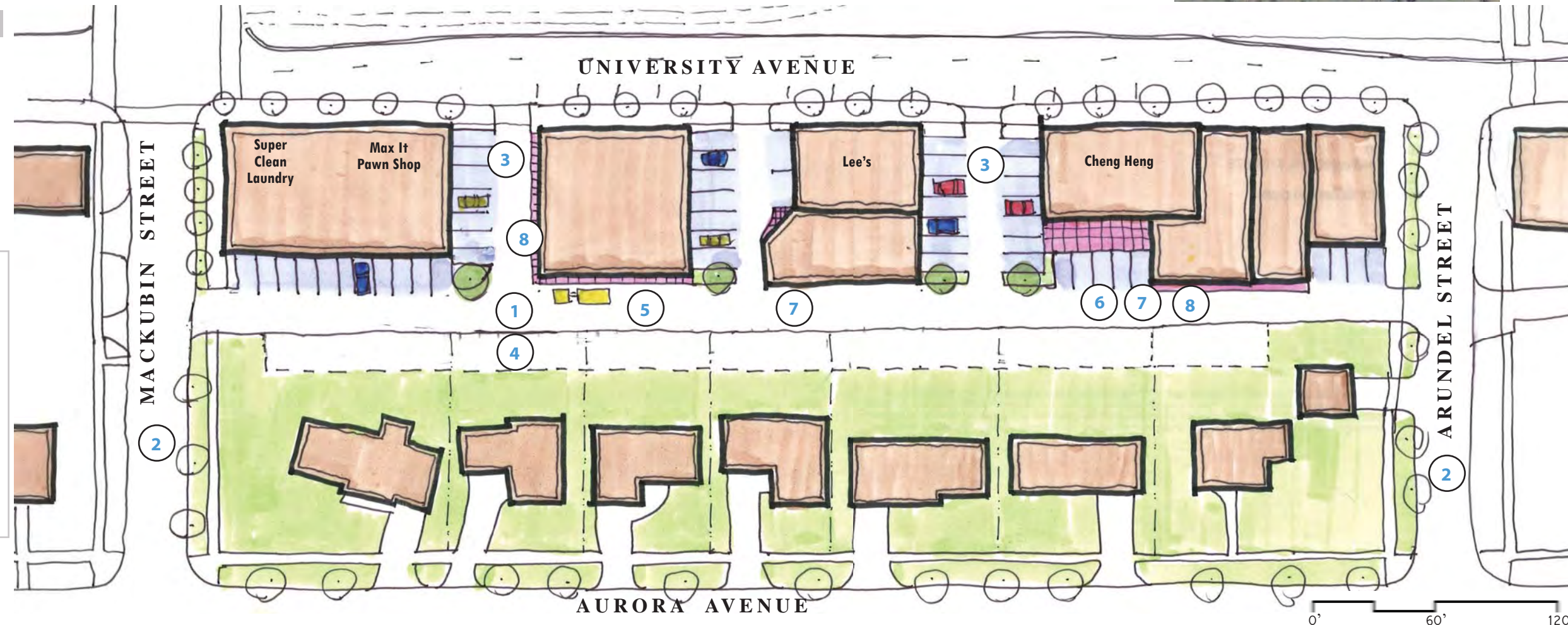

Potential Parking Solutions

1. Reestablish Alleyway for Improved Internal Circulation

- Demolish encroaching structures
- Access to rear buildings for deliveries, parking, and garbage collection
- Improve safety by not having a dead end alleyway
- Allow for parking south of corner businesses
- Improve business access during LRT construction

2. Enforce Short-term On-street Parking on Side Streets

- Preference for time-limited, not metered
- One-hour near University (north of alley)
- Two-hour near Aurora (south of alley)

3. Create Shared Parking Opportunities

- Signing for use by multiple businesses
- Create a formal shared parking agreement between property and business owners

4. Potential Alley Easement for Parking

- Improve conditions along the south side of the alley by rebuilding the retaining wall
- Work with neighbors to explore the option of an agreement for parking 20' south of alley
- Create a shared parking agreement/lease for benefiting properties

5. Deliveries and Loading

- Work with vendors to schedule most deliveries before 11AM or after PM traffic peak (6PM) when there is the least congestion
- Stop in right through-lane of University Avenue
- Explore strategies for ADA accessible loading
- Keep deliveries in the alley short to provide for good internal circulation and access to customer parking

6. Security and Personal Safety

- Lighting, new pedestrian walkways
- More visibility of security - bike police patrol, or

- Metro Transit police, private security guard
- Crime Prevention Through Environmental Design (CPTED).

- CPTED design group should make suggestions based on issues brought up during the parking workshop
- Explore the addition of back doors and windows on businesses to increase visibility

7. Shared Refuse and Recycling

- Commercial buildings should work with Minnesota WasteWise Program to consider consolidating dumpsters and recycling

8. Opportunities for New Accessible Walkways

- Various locations, especially new shared parking, would benefit from added pedestrian pathways leading to and from University Avenue
- Pathways should be ADA accessible, well-lit and landscaped to encourage better use of the off-street parking

Workshop Participants

- Greg Daniel - Max It Pawn/Cash and Pawn
- Le Pham - Lee's Auto Tech
- See Her - Super Clean Laundry
- Kevin Lam - Cheng Heng & 440, 446, 447, 448 University Avenue

P Western Avenue to Arundel Street, north side

Parking Workshop 1 - 05.20.2009



Parking Solutions Concept Plan:

The diagram illustrates the recommended parking solutions concepts. On this block, 18 on-street parking spaces will be lost due to LRT construction. The overarching goal is to use the alley for improved internal block circulation and for access to parking in the rear of buildings. Paved pedestrian areas can accommodate bike parking, outdoor dining, and access to and from University Avenue. The alley is used as an organizing element in the block.

- key**
- parking- new or reconfigured
 - paved area- limited vehicle use
 - paved area - pedestrian use
 - buildings
 - private land
 - landscape or stormwater opportunity
 - street tree - not to scale
 - new or relocated curb cut
 - existing curb cut to remain

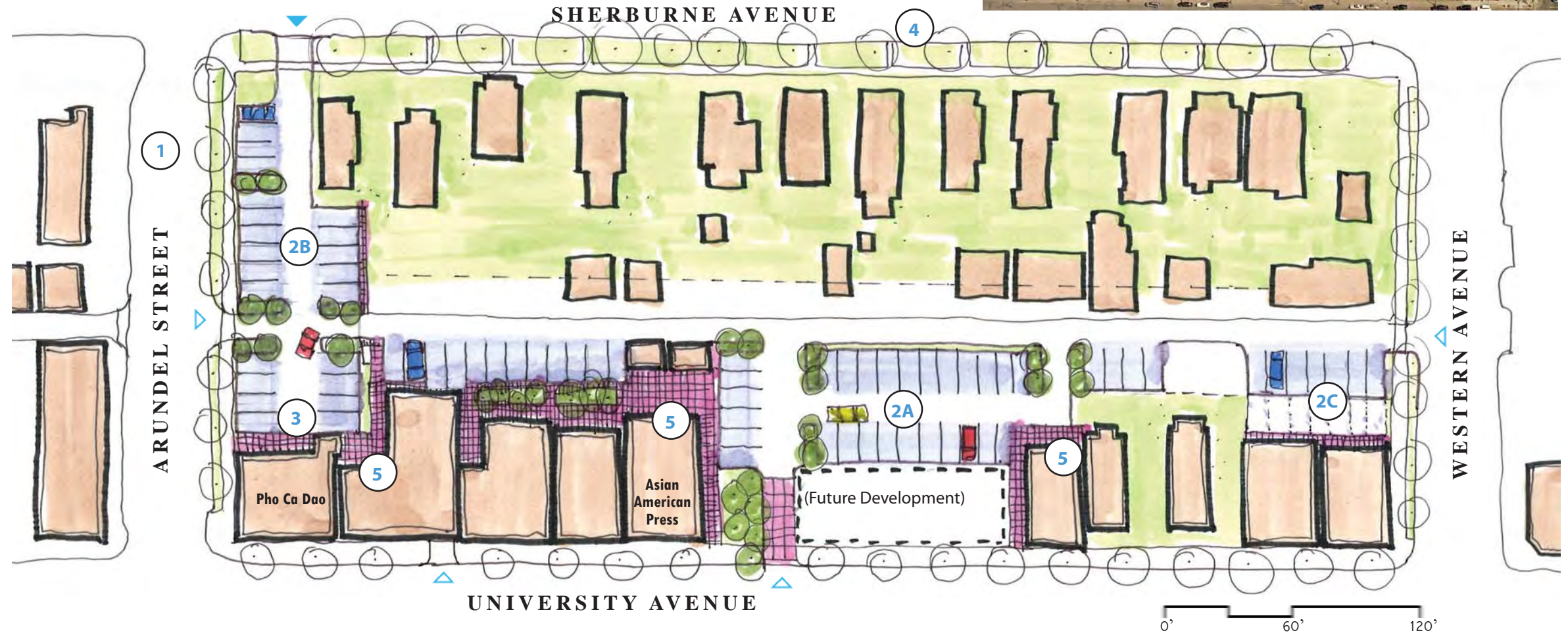

Potential Parking Solutions

1. Enforce Short-term On-street Parking on Side Streets

- Time-limited, not metered
- One-hour near University (south of alley)
- Two-hour near Sherburne (north of alley)

2. Create Shared Parking Opportunities

2A. Asian American Press & Ahn's Hairstylists Properties

- Signing for use by multiple businesses
- Create an alley opening to improve circulation
- Create a formal shared parking agreement between property and business owners
- With potential for new development on the vacant lot, new surface parking lot could add about 16 spaces
- Pervious pavement and/or bioswales could be included to help with stormwater management and greening, and provide a temporary use prior to redevelopment
- Parking on the adjacent property to the east (behind Ahn's Hairstylists) could be restriped to create a

larger shared parking area and an additional 1-3 spaces

2B. Hoang Pham Property

- Signing for use by multiple businesses
- Parking lot could be extended to Sherburne on the vacant lot by relocating the curb cut and with better landscaping to buffer neighboring residences
- Create a shared parking agreement/lease for benefiting properties
- An estimated 6-7 spaces could be gained in this area

2C. Pam Thao's Property and Space behind Neighboring Building

- Grading, remove barriers/fencing
- Restripe for more efficient parking design (6-8 spaces)
- Signing for use by multiple businesses
- Create a shared parking agreement between properties
- Employees park in stacked spaces

3. Shared Refuse and Recycling

- Commercial buildings near Arundel should work with the Minnesota WasteWise Program to consider consolidating dumpsters and recycling

4. Permit Parking

- Permit Parking should be studied for use north of the block
- Employees should be considered in this permit system to relieve spaces closer to businesses

5. Opportunities for New Accessible Walkways

- Various locations, especially new shared parking, would benefit from added pedestrian pathways leading to and from University Avenue
- Pathways should be ADA accessible, well-lit and landscaped to encourage better use of the off-street parking

Workshop Participants

- Ahn Trinh** - Ahn's Hairstylists
- Nghi Huynh** - Asian American Press
- Pam Thao** - Lee's Tax & Payroll & Quality Plus Home Health Care
- Alex Pham** - Pho Ca Dao Restaurant
- Cuong Dang** - Kim Dung Jewelry
- Maria Nguyen** - Quinhon, Inc.
- Hoang Pham** - Quinhon, Inc.

P Galtier Street to Western Avenue, north side

Parking Workshop 4- 06.08.2009



Parking Solutions Concept Plan:

The map above illustrates the recommended parking solutions concepts. On this block, 9 on-street parking spaces will be lost due to LRT construction. Parking areas are reorganized in order to create shared parking lot opportunities and to add amenities for stormwater, pedestrian spaces, bike parking, and outdoor cafes. There is not a traditional alleyway on this block, so the drivelane for parking lots is configured to be a shared circulation route and will provide access to buildings during construction.

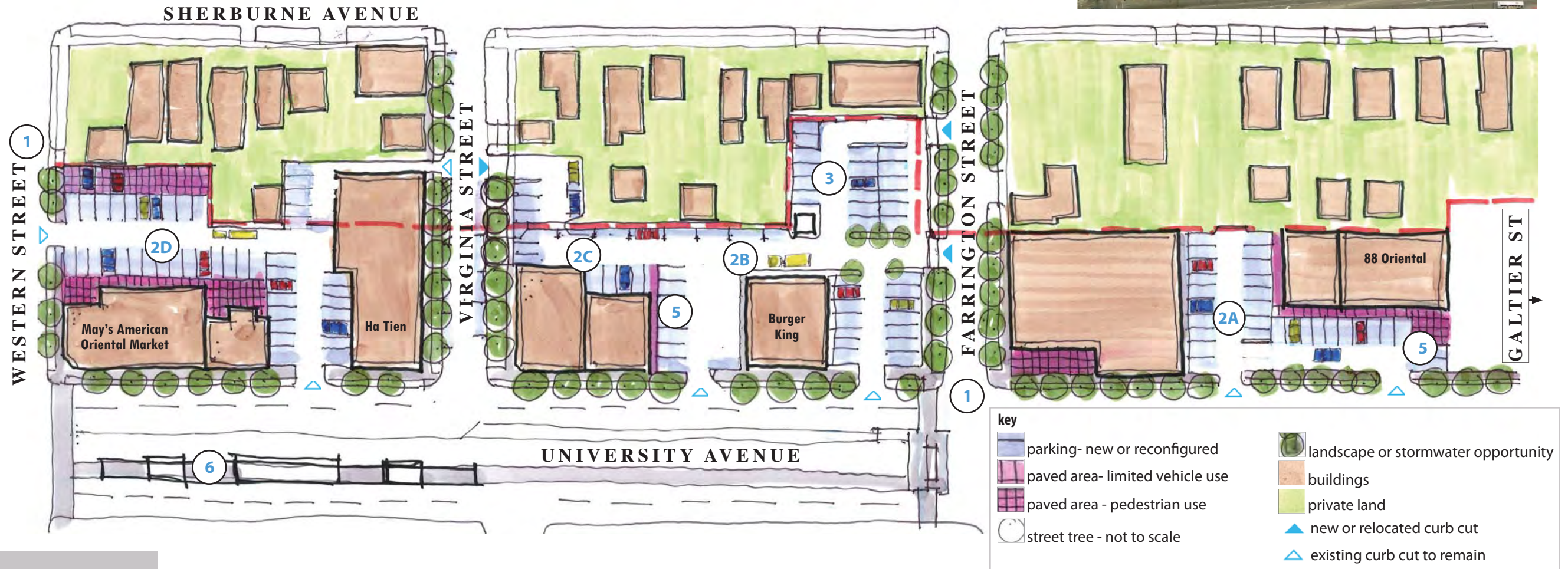

Potential Parking Solutions

1. On-street Parking on Farrington and Galtier

- Coordinate width of street, room for trucks/buses to turn around
- Time-limited parking preferred on Virginia
- Farrington and Galtier considered for meters

2. Create Shared Parking Opportunities

2A. 88 Oriental/Bangkok Mall/Animal Hospital

- Reconfigure curb-cuts and parking grade to combine adjacent lots
- Add signage for businesses served
- Animal hospital has complimentary parking at certain times
- Explore shared parking agreement with Burger King's lot

2B. Burger King

- Shared back lot add curb cut on Farrington, restripe

2C. Organize/Reconfigure lots behind buildings in NE Quadrant of Virginia/University

- Currently used as parking and owned by supermarket
- Should be re-zoned to allow for commercial parking and then be included in the Central Corridor Zoning Overlay District.
- Move curb cut North on Virginia behind supermarket
- Allows for trash consolidation
- Reconfigure lot

2D. May's Market/Ha Tien

- Move curb cut on Western and develop tandem parking north of May Yang's building.
- Restripe/reconfigure lot
- Make north side of building tandem spaces for employees
- Add signage
- Access maintained to side streets
- Improve rear entrances

3. Remote Employee Parking

- Potential/explore shared (employee) parking to remove employees from using lot in front of building

4. Travel Demand Management

- Encourage the use of mass transit with Metro Pass

5. Add/Formalize ADA Pedestrian Walkways

6. LRT Station at Western

Workshop Participants

- Peter Ratsamy - 88 Oriental Foods
- Ne Dao - Ha Tien Grocery Store
- May Yang - May's American-Oriental Market
- Sunday Olayinka - Metro Social Services

P Design Guidelines

CIRCULATION

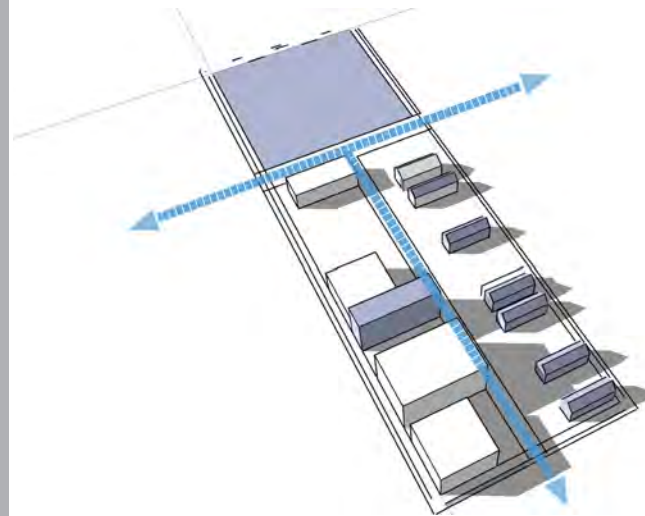

Internal Circulation

- Minimum width for new alleys= 24'
- Alleys are to be either T or L-shaped if they do not run parallel to the length of the block
- Alleys are to be utilized for deliveries and access to the rear of buildings fronting University Avenue
- Where possible, alleys may serve as parking lot driveways, reducing drive lane redundancy
- Alleys provide secondary circulation routes

ALLEY PARKING

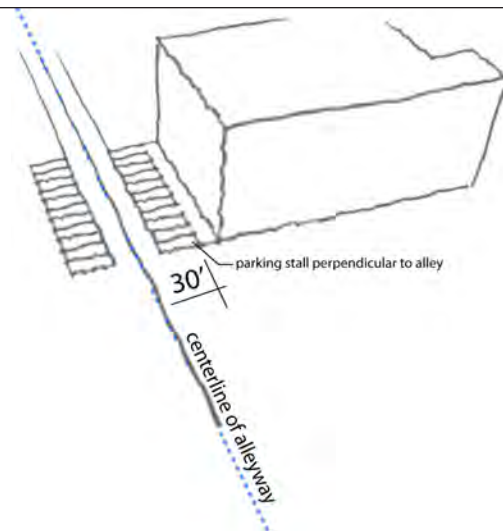

Alleys: Parking

- 30' offset from alley centerline allows for perpendicular parking spaces.
- Maximize alley ways for circulation, access, and parking opportunities
- Agreements with residential properties may increase available space for parking thereby creating double loaded parking in alley way.
- Parking opportunity for employees and customers
- Opportunity to organize rear parking spaces for improved safety and visibility

ACCESS

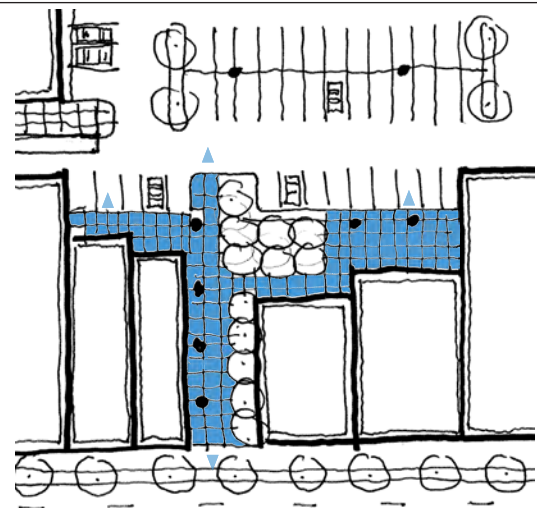

Interior Block Access & Amenities

- Clear pathways to provide for safe pedestrian access and circulation
- Defined pedestrian walkways with paving material, striping, or physical delineation using bollards or curbs.
- Mid-block connections to University aid in the pedestrian circulation and improve access to commercial areas on University.
- Crime Prevention through Environmental Design- CPTED principles
- Details for: Bike parking, security, lighting, landscape, waste/recycling, pathways

STORMWATER

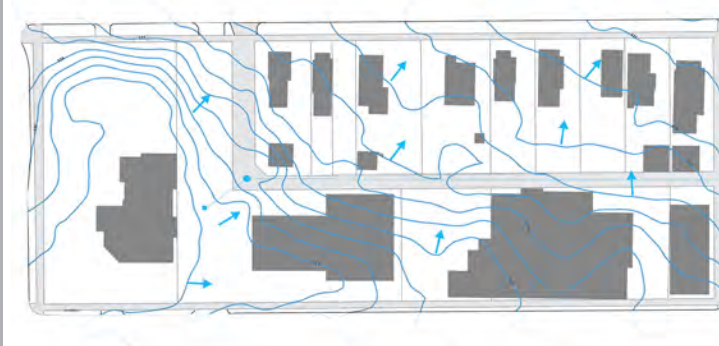

Integrated Landscaping & Stormwater Management

- Stormwater management on a site or block scale
- The water quality manual suggests practices and resources to guide planning for stormwater management and landscape systems.

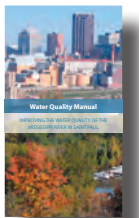

DIMENSIONS

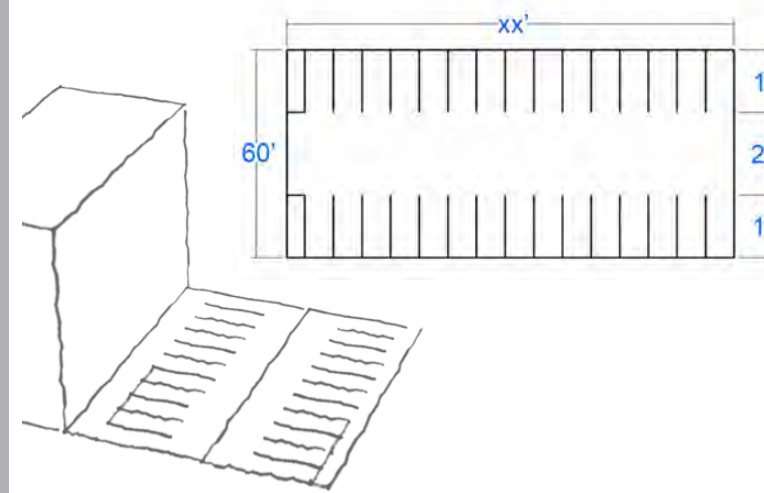

Parking Dimensions - land area

- Double loaded parking lots are required to be 60' wide to allow for perpendicular parking, adequate two way driveways.
- Serves as a planning grid for structure parking and future building placement

ALLEY EDGE



Stabilize the Residential Alley Edge

- Garage Improvements
- Fence
- Lighting
- Dumpsters
- Parking Courts or parking pads

Pre-Application Form

Project Name: _____

Project Address: _____

Business(es) or Property Owner(s) submitting proposal: _____

Main Contact Person Completing the Application:

| NAME (PLEASE TYPE/PRINT) | TITLE (IF APPLICABLE) | DATE | SIGNATURE |
|--------------------------|-----------------------|------|-----------|
| | | | |

Daytime Phone: () _____ E-mail Address: _____

Main Contact Mailing Address: _____
STREET City State Zip Code

Property Owner or Representative (if different):

| NAME (PLEASE TYPE/PRINT) | TITLE (IF APPLICABLE) | DATE | SIGNATURE |
|--------------------------|-----------------------|------|-----------|
| | | | |

Loan request amount: \$ _____

PROPOSAL INFORMATION:

- Please **attach** a description of your project.
- Check the anticipated benefits that can be expected from this project. Please place a "1" next to the item you believe is the primary benefit, and a "2" next to the item you select as a secondary benefit:

| | | | | | |
|--------------------------|---------------------------------------|--------------------------|---|--------------------------|--|
| <input type="checkbox"/> | Maximize utilization of existing lots | <input type="checkbox"/> | Provide foundation for infill development | <input type="checkbox"/> | Increase stormwater management |
| <input type="checkbox"/> | Increase ADA access | <input type="checkbox"/> | Improve personal safety | <input type="checkbox"/> | Encourage biking, walking, and transit |
| <input type="checkbox"/> | Improve auto circulation | <input type="checkbox"/> | Create shared parking | <input type="checkbox"/> | Innovative/Demonstration practice |
| <input type="checkbox"/> | Improve pedestrian circulation | <input type="checkbox"/> | Improves access during LRT construction | <input type="checkbox"/> | Leverage other funding |
| <input type="checkbox"/> | Provides a buffer to residential uses | <input type="checkbox"/> | Add/improve landscaping and aesthetics | <input type="checkbox"/> | Benefit a parking "critical area" |

- Please provide a rough estimate of how much of the loan request will be used in each category. Examples are:

| | |
|------------------------------|---|
| Infrastructure improvements: | capital improvements to existing surface parking or alley, paving, striping, driveways, walls, fences |
| Pedestrian improvements: | lighting, ramps, new/improved building entrances, walkways, accessibility |
| Landscaping improvements: | plantings, stormwater management, brush removal |
| Efficiency improvements: | consolidating dumpsters or recycling, removing or repairing garages, bike parking, shared parking signage, etc. |

| CATEGORY | LOAN REQUEST | OTHER FUNDS* | TOTAL |
|--|--------------|--------------|-------|
| Infrastructure improvements | | | |
| Pedestrian improvements | | | |
| Landscaping improvements | | | |
| Efficiency improvements | | | |
| ** Direct Project Costs (limit to 10%) | | | |
| *** Other Eligible Costs | | | |
| TOTALS: | | | |

* Not Required. **Direct Project Costs (Soft Costs) - Up to 10% of funds may be used for soft costs (i.e. architect, engineering, legal and loan fees, permits, licenses.) Soft costs do not include general administrative expenses, rent, marketing, or operating costs. ***Other: Please provide a separate sheet with a **detailed explanation** and specific costs included in this category.

Pre-Application Instructions

Thank you for your interest in the City of Saint Paul's Neighborhood Commercial Parking Program. Before you begin, please read the following:

The purpose of the Neighborhood Commercial Parking Pilot Program (NCPP) is to provide forgivable loans for improvements to off-street parking along University Avenue. The program is being piloted to help mitigate the proposed loss of on-street parking due to Central Corridor Light Rail Transit. The NCPP will fund a limited number of projects that improve parking management, increase the amount and utilization of commercial parking, and/or encourage business and property owners to equitably share the use and costs of off-street parking.

A successful application for these public dollars will demonstrate cost-effective projects that improve the safety, appearance, or utilization of parking, or increase the amount of off-street parking; have a commitment of human and financial resources; and conform to acceptable credit/loan standards. All business and property owners with frontage on University Avenue between Emerald Street and Rice Street in Saint Paul are eligible for this program. Priority will be given to projects within the 11 critical areas identified in the recent report, [Mitigating the Loss of Parking in the Central Corridor](#).^{*} Competitive forgivable loans will be available for **up to \$25,000**, although larger loans will be considered where multiple businesses and/or property owners cooperate on a shared parking agreement and submit a single application.

You are encouraged to include neighborhood partners & business partners in the development of your project proposal. City staff and translators are also available to assist with your proposal.

All potential applicants are strongly encouraged (but not required) to submit a pre-application to City staff. Staff will provide preliminary feedback and help applicants create eligible and competitive proposals. Pre-Applications will be accepting on a rolling basis through December 2009.

For the pre-application phase, please submit the following:

- Completed Pre-Application Form
- Map identifying the project location

Mail or Deliver to: Neighborhood Commercial Parking Program
 ATTN: Craig Blakely
 Dept of Planning and Economic Development
 25 West Fourth Street, 13th Floor
 Saint Paul, Minnesota 55102-1622

- or -

Email to: craig.blakely@ci.stpaul.mn.us (please put "NCPP pre-application" and the address of your proposed project in the subject line of your email)

Questions should be directed to city staff, Craig Blakely at (651)266-6697, or craig.blakely@ci.stpaul.mn.us

^{*}Report can be viewed at www.stpaul.gov/DocumentView.aspx?DID=8599.